

# KM SERIES

## 160~200W DC/DC CONVERTERS 並列運転可能 Parallel Operation

KMU type



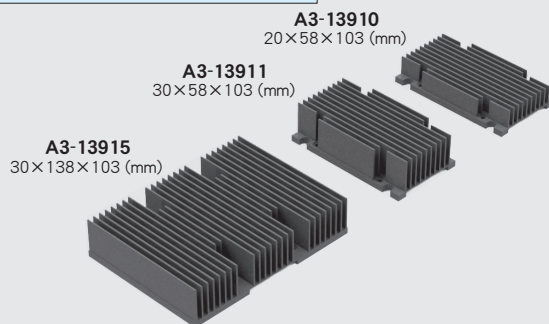
H20×W60×L135 (mm)

KMS type



H20×W60×L135 (mm)

### Option Heat Sink



### Features

- Built-in Input Filter
- Input-Output Isolation
- High Efficiency 87~91%
- Wide Input Voltage Range
- High Reliability
- Adjustable Output Volt. ±10%
- Input Low Voltage Protection
- Input Over Voltage Protection
- Output Over Voltage Protection
- Thermal Protection  
+110°C~+120°C
- Remote ON/OFF Control
- Possible Parallel Operation  
up to 3 converters
- Operating Ambient Temperature  
-40°C~+85°C
- Conformity to RoHS Directive
- Not built-in aluminum and  
tantalum electrolytic capacitor
- 入力フィルタ内蔵
- 入出力間絶縁
- 高効率 87~91%
- 広範囲な入力電圧
- 高信頼性
- 可変出力電圧 ±10%
- 入力低電圧保護回路内蔵
- 入力過電圧保護回路内蔵
- 出力過電圧保護回路内蔵
- 過熱保護回路内蔵  
+110°C~+120°C
- リモートON/OFFコントロール
- 3台まで並列運転可能
- 動作周囲温度  
-40°C~+85°C
- RoHS指令対応
- アルミ電解コンデンサ及び  
タンタルコンデンサ不使用

### Selection Guide

Table 1

Model Number	Input Volt. (Range) (V. DC)	Output Voltage (V. DC)	Output Current (A)	Efficiency (Typical)(%)		
				20% Load	50% Load	80% Load
KMU(KMS) 12- 3.3S 32A	12 (8~18) at 50% Load (9~18) at 100% Load	3.3	32	85	88	87
		5	32	86	90	89
		6	26.6	86	90	89
		12	13.4	87	90	89
		13.8	11.6	87	90	89
		15	10.7	87	90	89
		24	6.7	87	90	89
		28	5.8	87	90	89
		48	3.4	87	90	89
		48	3.4	87	90	89
		3.3	40	88	91	90
		5	32	90	92	91
KMU(KMS) 24- 5S 32A	24 (16~36)	6	26.6	90	92	91
		12	16.7	90	92	91
		13.8	14.5	90	92	91
		15	13.4	90	92	91
		24	8.4	90	92	91
		28	7.2	90	92	91
		48	4.2	90	92	91
		3.3	40	88	91	90
		5	32	91	92	91
		6	26.6	91	92	91
		12	16.7	91	92	91
		KMU(KMS) 48- 3.3S 40A	48 (36~76)	3.3	40	88
5	32			91	92	91
6	26.6			91	92	91
12	16.7			91	92	91
13.8	14.5			91	92	91
15	13.4			91	92	91
24	8.4			91	92	91
28	7.2			91	92	91
48	4.2			91	92	91
3.3	40			85	91	90
5	32			87	92	91
KMU(KMS)100- 3.3S 40A	100 (64~144)			5	32	87
		6	26.6	87	92	91
		12	16.7	87	92	91
		13.8	14.5	87	92	91
		15	13.4	87	92	91
		24	8.4	87	92	91
		28	7.2	87	92	91
		48	4.2	87	92	91
		3.3	40	85	91	90
		5	32	87	92	91
		6	26.6	87	92	91
		KMU(KMS)140- 5S 32A	140 (90~200)	12	16.7	87
13.8	14.5			87	92	91
15	13.4			87	92	91
24	8.4			87	92	91
28	7.2			87	92	91
48	4.2			87	92	91
3.3	40			85	91	90
5	32			87	92	91
6	26.6			87	92	91
12	16.7			87	92	91
13.8	14.5			87	92	91

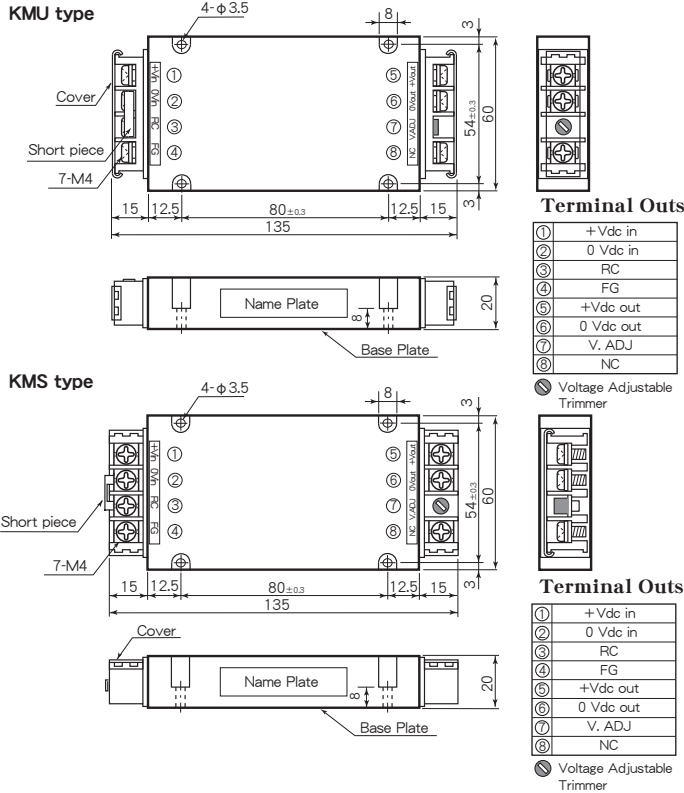
\* 上記仕様以外にも対応可能ですのでお問い合わせください。  
Please consult with us about other specification.

### General Characteristics

- Input Voltage, Range DC12, 24, 48, 100, 140V (See Table 1)
- Output Voltage, Current See Table 1
- Output Voltage Range ±10% Adjustable
- Efficiency See Table 1
- Line Regulation ±0.3% max. (at Vin Range)
- Load Regulation 3% max. (0~100% Load) (See Fig 6)
- Reflected Input Ripple, Noise (5% Vin)Vp-p max.
- Output Ripple 80mVp-p max.
- Output Noise (0.5% Vout+100mV)p-p max.
- Short Circuit Protection Built-in, Auto-restart (See Fig 5)
- Over Voltage Protection 115~140% Output Voltage
- Remote ON/OFF Control ON: Short or 0~0.8V  
OFF: Open or 2~10V  
(Between terminal ② ~ ③)
- Temperature Coefficient 0.02%/°C max.
- Operating Ambient Temp. -40°C~+85°C (See Fig 1)
- Max. Case Temperature +105°C
- Storage Temperature -55°C~+125°C
- Isolation Voltage AC2000V one minute  
(Input-Output-Case)
- Isolation Impedance 100MΩ min. (at DC1000V)  
(Input-Output-Case)
- Weight Main Body : 350g max.  
Heat Sink  
A3-13910 : 135g max.  
A3-13911 : 175g max.  
A3-13915 : 425g max.
- Humidity 20~95% RH
- Shock 490m/s<sup>2</sup> (11msec 3directions)
- Vibration 10~55Hz 98m/s<sup>2</sup>  
(30minutes 3directions)
- Surface Structure Aluminum Case
- MTBF 400,000H  
(Ta:25°C, 80%Load, Nominal Vin)
- Warranty 5 years

# KM SERIES DATA SHEET

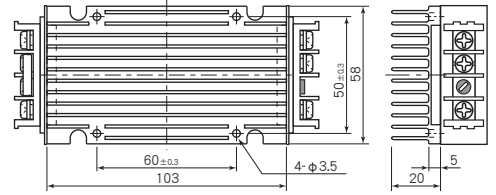
## Terminal Outs & Dimensions ( $\pm 0.5\text{mm}$ )



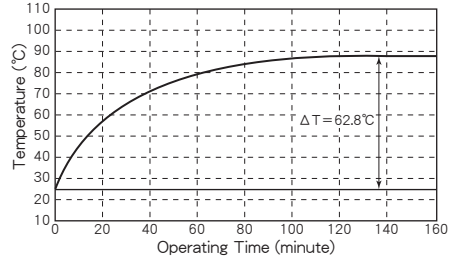
## Option Heat Sink

**Fig 2 Temperature Characteristic on Case Surface**

\* Option Heat Sink Model : A3-13910

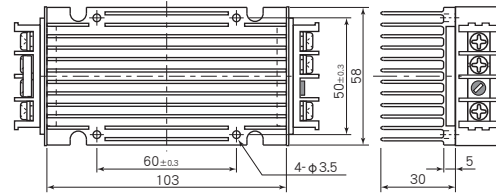


KMU24-12S16.7A Additional Heat Sink A3-13910  
Ta=25°C, 80% Load, Vin=Nominal

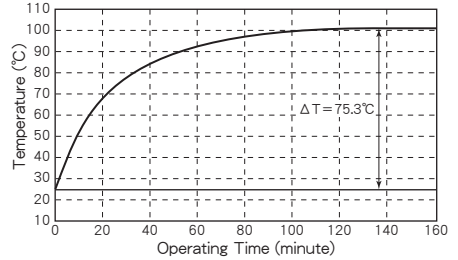


**Fig 3 Temperature Characteristic on Case Surface**

\* Option Heat Sink Model : A3-13911

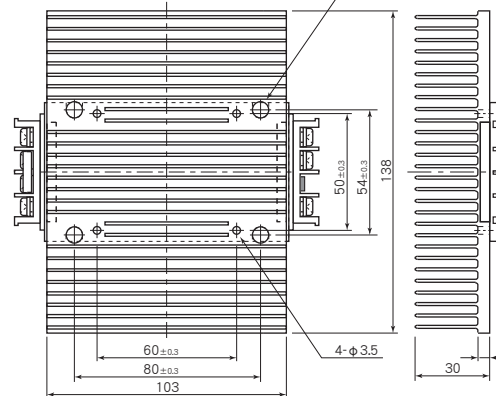


KMU24-12S16.7A Additional Heat Sink A3-13911  
Ta=25°C, 100% Load, Vin=Nominal

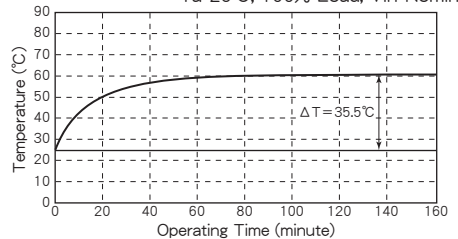


**Fig 4 Temperature Characteristic on Case Surface**

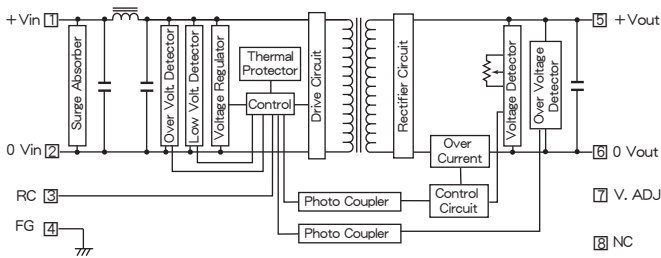
\* Option Heat Sink Model : A3-13915



KMU24-12S16.7A Additional Heat Sink A3-13915  
Ta=25°C, 100% Load, Vin=Nominal

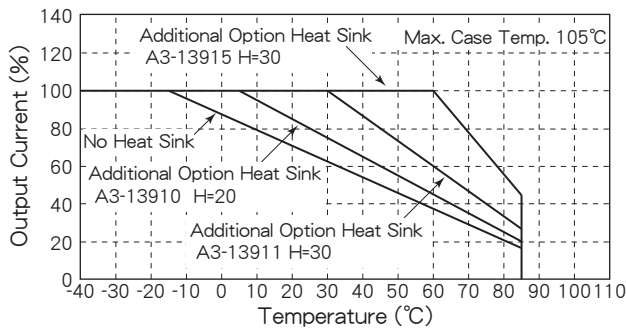


## Block Diagram



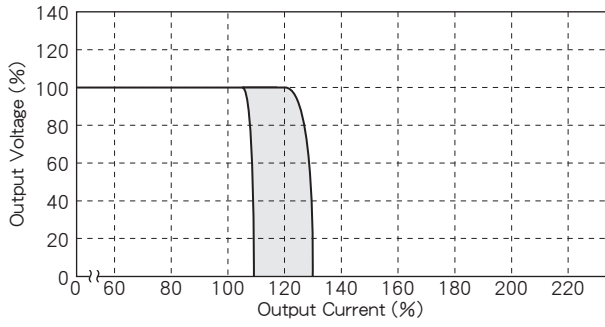
## Characteristic Curves

**Fig 1 Derating Curve**

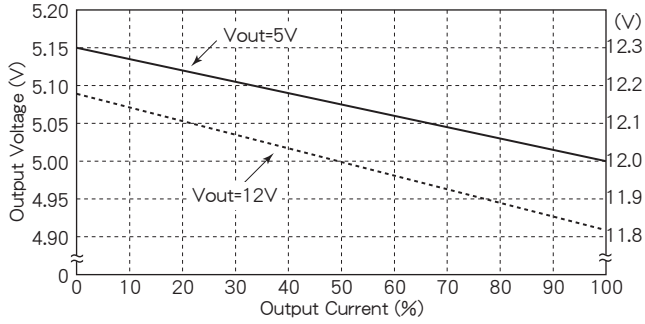


# KM SERIES DATA SHEET

**Fig 5 Short Circuit Operating Area**

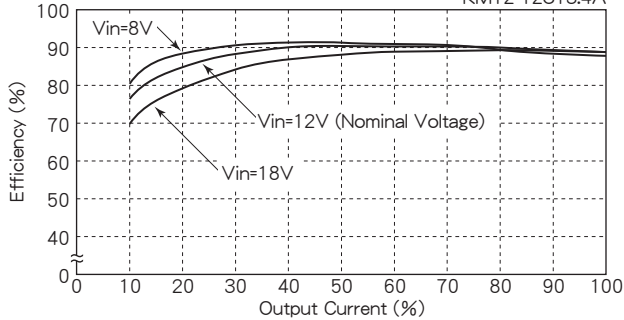


**Fig 6 Output Voltage vs. Output Current**

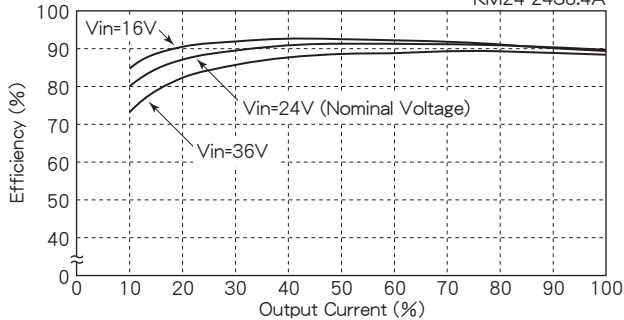


\* 並列運転時に各モジュールの電流を平均化するため  
 負荷変動を大きくしてあります。  
 Load Regulation is regulated large on purpose to equate  
 the each unit's output current at parallel operation.

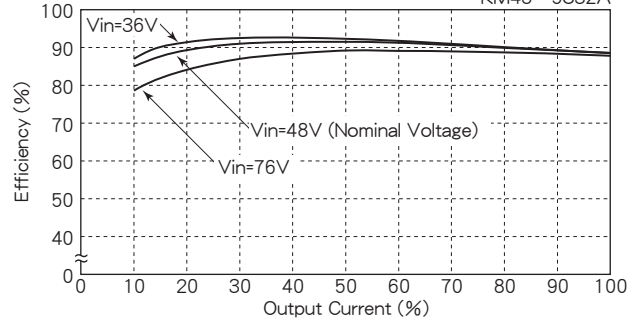
**Fig 7 Efficiency vs. Output Current**



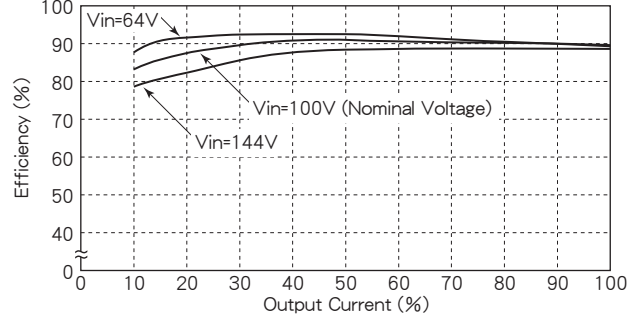
**Fig 8 Efficiency vs. Output Current**



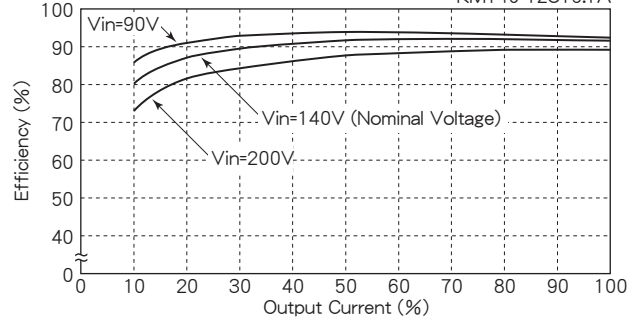
**Fig 9 Efficiency vs. Output Current**



**Fig 10 Efficiency vs. Output Current**



**Fig 11 Efficiency vs. Output Current**



## Parallel Operation

同機種を並列に動作させることにより、出力電流容量を増やすことができます。下図のように結線し、各コンバータ間の出力電圧を同じ電圧に調整することで、並列運転ができます。(Fig 12を御参照ください)

It is possible to increase output current capacity by parallel operation of the same model. Please see the below figure for wiring instruction. Parallel operation is possible by each outputs to be same voltage.

Fig 12 Parallel Operation Connection

